

C4005_90

Rychlospojka s trnem pro nástrčnou hadici, 90°

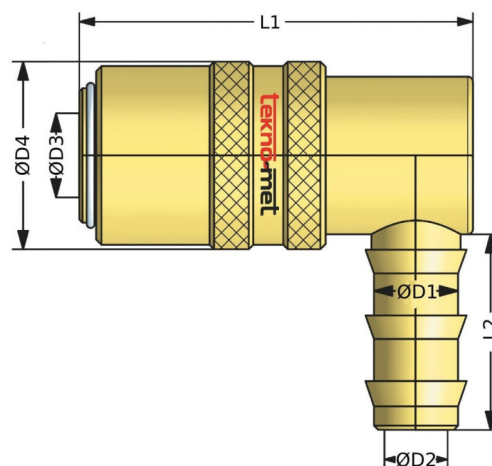
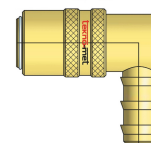

kód	D3	D1	D2	D4	L1	L2	uzavírací ventil
C4005-V/9-6-90	9	6	4	17	48	24	ano
C4005/9-6-90	9	6	4	17	48	24	ne
C4005-V/9-9-90	9	9	6	17	48	24	ano
C4005/9-9-90	9	9	6	17	48	24	ne
C4005-V/9-10-90	9	10	7	17	48	24	ano
C4005/9-10-90	9	10	7	17	48	24	ne
C4005-V/9-13-90	9	13	10	17	48	28	ano
C4005/9-13-90	9	13	10	17	48	28	ne
C4005-V/13-10-90	13	10	7	22	55	28	ano
C4005/13-10-90	13	10	7	22	55	28	ne
C4005-V/13-13-90	13	13	10	22	55	28	ano
C4005/13-13-90	13	13	10	22	55	28	ne
C4005-V/19-16-90	19	16	13	31	84	38	ano
C4005/19-16-90	19	16	13	31	84	38	ne
C4005-V/19-19-90	19	19	15	31	84	38	ano
C4005/19-19-90	19	19	15	31	84	38	ne
C4005-V/19-25-90	19	25	19	31	84	38	ano
C4005/19-25-90	19	25	19	31	84	38	ne