

Dimensions and tolerances
Wymiary i tolerancje
Abmessungen und Toleranzen
Размеры и допуски



	A	B	C
PK	474	380	424
PKA	474	380	424

PK 01
PKA 01



	W
PK 01	596
PKA 01	546

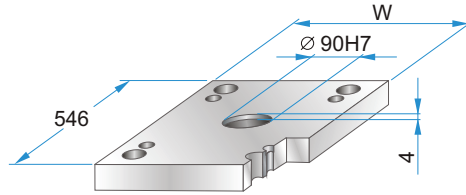

PK 01 - 496 x 546 x h /	PKA 01-496 x 546 x h /	material
36	1730	
46	2312	
56	2085	

PK 11
PKA 11



	W
PK 11	596
PKA 11	546

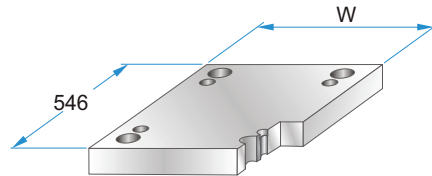

PK 11 - 496 x 546 x h /	PKA 11-496 x 546 x h /	material
36	1730	
46	2312	
56	2085	

PK 02
PKA 02



PK 12
PKA 12



PK 21
PKA 21

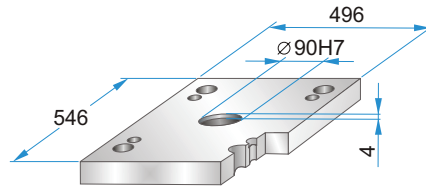

PK 21 - 496 x 546 x h /	PKA 21-496 x 546 x h /	material
27	1730	
36	2312	
46	2085	

PK 22
PKA 22

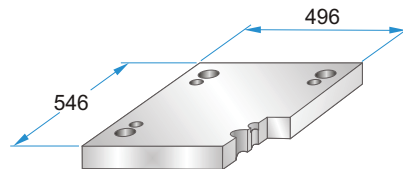

PK 22 - 496 x 546 x h /	PKA 22-496 x 546 x h /	material
27	1730	
36	2312	
46	2085	

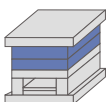

PK 03
PKA 03

PK 35
PKA 35

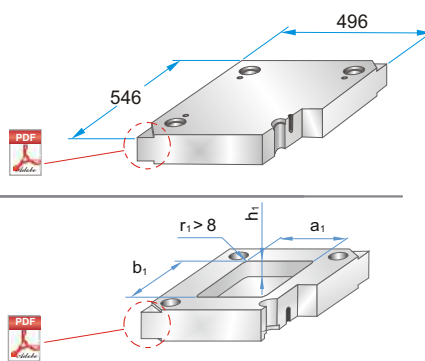

PK 03 - 496 x 546 x h /	PKA 03-496 x 546 x h /	material
27	1730	
36	2083	
46	2085	
56	2162	
66	2311	
76	2312	
86	2738	
96	Toolox33	
116	Toolox44	
136	2738HH	
156	2714HH	
176		

Material info



Corner undercuts upon request.
Podcięcia do demontażu na życzenie.
Abhebeecken erhältlich.
Доступно высвобождение на углах плит.

PK 31
PKA 31

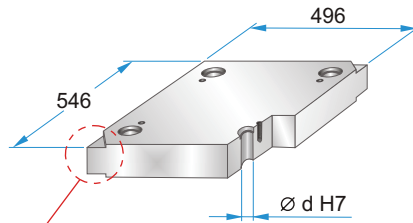
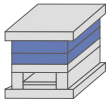

Corner undercuts upon request.
Podcięcia do demontażu na życzenie.
Abhebeecken erhältlich.
Доступно высвобождение на углах плит.



	d
PK 31	41,3
PKA 31	41,4

PK 31 - 496 x 546 x h /
PKA 31-496 x 546 x h / material

27	1730
36	2083
46	2085
56	2162
66	2311
76	2312
86	2343
96	2738
116	2767
136	Toolox33
156	Toolox44
176	2738HH
	2714HH

Material info 

PK 04
PKA 04

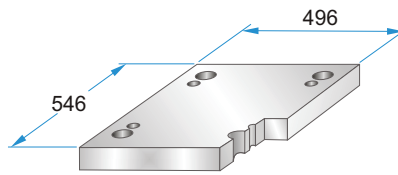
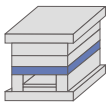

PK 04 - 496 x 546 x h /
PKA 04-496 x 546 x h / material

46	1730
56	2312
66	2085
76	
86	
96	

PK 05
PKA 05

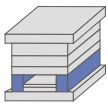

	A	B	M
PK 05	62	372	----
PKA 05	62	372	M10

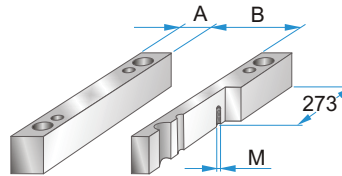

PK 05 - 496 x 546 x h /
PKA 05-496 x 546 x h / material

66	1730
76	2085
86	
96	
116	
136	
156	

PK 55
PKA 55

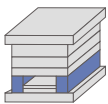

	A	B	M
PK 55	86	324	----
PKA 55	86	324	M10

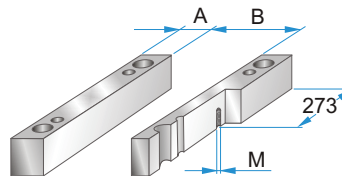

PK 55 - 496 x 546 x h /
PKA 55-496 x 546 x h / material

66	1730
76	2085
86	
96	
116	
136	
156	

PK 06
PKA 06



	A	B	C
PK 06	464	336	368
PKA 06	410	330	368

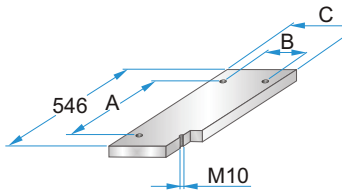

PK 06 - 496 x 546 x h /
PKA 06-496 x 546 x h / material

22	1730
27	2085

PK 65
PKA 65



	A	B	C
PK 65	464	288	320
PKA 65	410	280	318

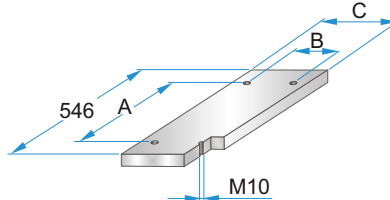

PK 65 - 496 x 546 x h /
PKA 65-496 x 546 x h / material

22	1730
27	2085

PK 07
PKA 07

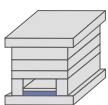

	A	B	C	D	M
PK 07	464	336	368	514	M4
PKA 07	410	330	368	508	M5

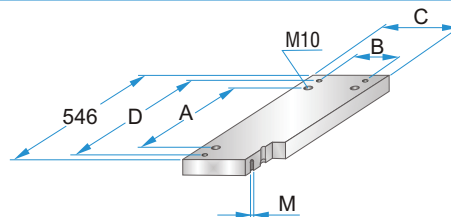

PK 07 - 496 x 546 x h /
PKA 07-496 x 546 x h / material

27	1730
36	2312
	2085

PK 75
PKA 75

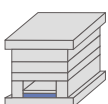

	A	B	C	D	M
PK 75	464	288	320	514	M4
PKA 75	410	280	318	508	M5

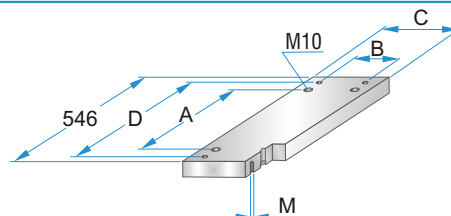

PK 75 - 496 x 546 x h /
PKA 75-496 x 546 x h / material

27	1730
36	2312
	2085