

Dimensions and tolerances
Wymiary i tolerancje
Abmessungen und Toleranzen
Размеры и допуски



	A	B	C
PK	624	530	274
PKA	624	530	274

PK 01
PKA 01



	W
PK 01	446
PKA 01	396

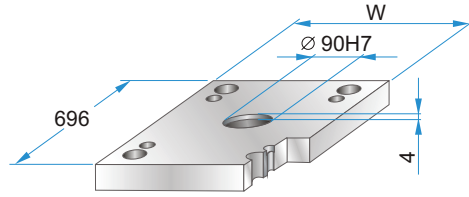

PK 01 - 346 x 696 x h / material

PKA 01-346 x 696 x h /	material
36	1730
46	2312
	2085

PK 11
PKA 11



	W
PK 11	446
PKA 11	396

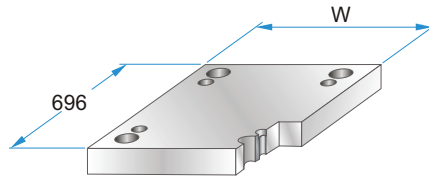

PK 11 - 346 x 696 x h / material

PKA 11-346 x 696 x h /	material
36	1730
46	2312
	2085

PK 02
PKA 02

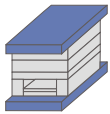

PK 12
PKA 12

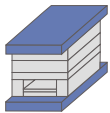

PK 21
PKA 21

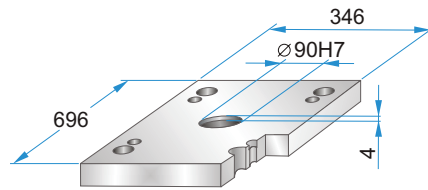

PK 21 - 346 x 696 x h / material

PKA 21-346 x 696 x h /	material
27	1730
36	2312
46	2085

PK 22
PKA 22

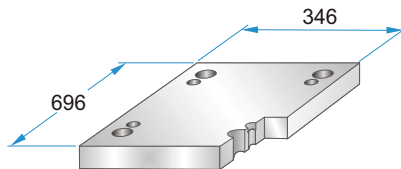

PK 22 - 346 x 696 x h / material

PKA 22-346 x 696 x h /	material
27	1730
36	2312
46	2085

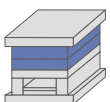

PK 03
PKA 03

PK 35
PKA 35

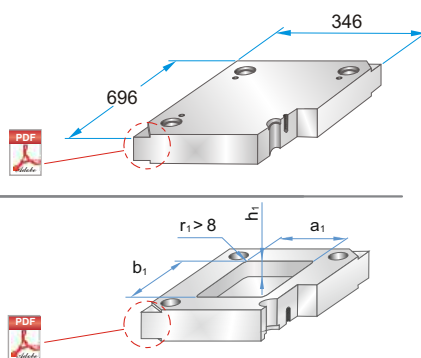

PK 03 - 346 x 696 x h / material

PKA 03-346 x 696 x h /

PK 35 - 346 x 696 x h / material

PKA 35-346 x 696 x h / (a1/b1/h1/r1)

22	1730
27	2083
36	2085
46	2162
56	2311
66	2312
76	2738
86	Toolox33
96	Toolox44
116	2738HH
136	2714HH
156	
176	

Material info



Corner undercuts upon request.
Podcięcia do demontażu na życzenie.
Abhebeecken erhältlich.
Доступно высвобождение на углах плит.

PK 31

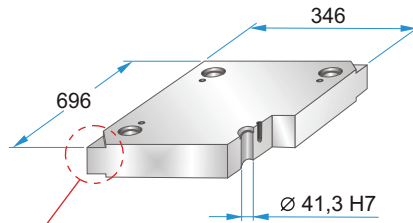
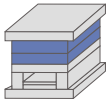

Corner undercuts upon request.
Podcięcia do demontażu na życzenie.
Abhebeecken erhältlich.
Доступно высвобождение на углах плит.



PK 31 - 346 x 696 x h / material

27	1730
36	2083
46	2085
56	2162
66	2311
76	2312
86	2343
96	2738
116	2767
136	Toolox33
156	Toolox44
	2738HH
	2714HH

Material info

PK 04 PKA 04

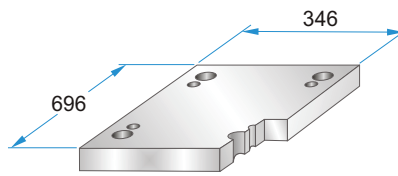
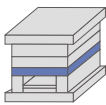

PK 04 - 346 x 696 x h /
PKA 04-346 x 696 x h / material

36	1730
46	2312
56	2085
66	
76	

PK 05 PKA 05

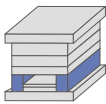

	A	B	M
PK 05	62	222	----
PKA 05	62	222	M10

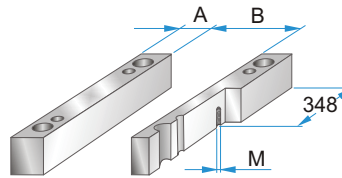

PK 05 - 346 x 696 x h /
PKA 05-346 x 696 x h / material

56	1730
66	2085
76	
86	
96	
116	
136	
156	

PK 55 PKA 55

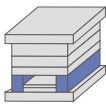

	A	B	M
PK 55	86	174	----
PKA 55	86	174	M10

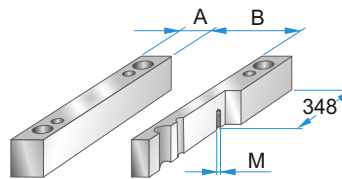

PK 55 - 346 x 696 x h /
PKA 55-346 x 696 x h / material

56	1730
66	2085
76	
86	
96	
116	
136	
156	

PK 06 PKA 06

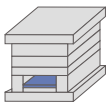

	A	B	C
PK 06	620	190	218
PKA 06	560	180	218

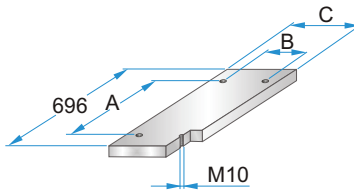

PK 06 - 346 x 696 x h /
PKA 06-346 x 696 x h / material

22	1730
27	2085

PK 65 PKA 65

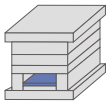

	A	B	C
PK 65	620	142	170
PKA 65	560	134	172

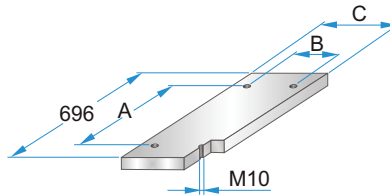

PK 65 - 346 x 696 x h /
PKA 65-346 x 696 x h / material

22	1730
	2085

PK 07 PKA 07

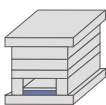

	A	B	C	D	M
PK 07	620	190	218	666	M4
PKA 07	560	180	218	658	M5

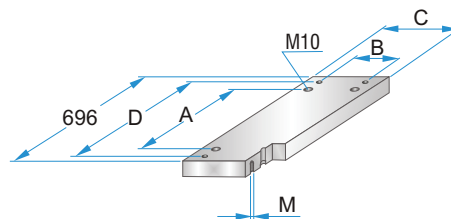

PK 07 - 346 x 696 x h /
PKA 07-346 x 696 x h / material

27	1730
36	2312
	2085

PK 75 PKA 75

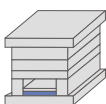

	A	B	C	D	M
PK 75	620	142	170	666	M4
PKA 75	560	134	172	658	M5

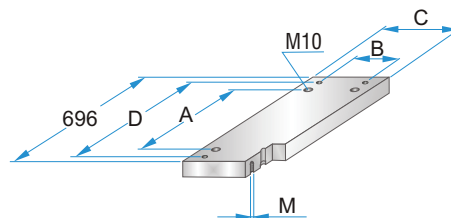

PK 75 - 346 x 696 x h /
PKA 75-346 x 696 x h / material

27	1730
	2312
	2085