

Dimensions and tolerances
Wymiary i tolerancje
Abmessungen und Toleranzen
Размеры и допуски

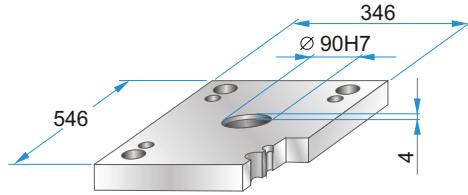

	A	B	C
PK	494	424	244
PKA	498	420	248

PK 01
PKA 01



PK 01 - 296 x 546 x h /	material
PKA 01-296 x 546 x h /	
36	1730
46	2312
	2085

PK 11
PKA 11

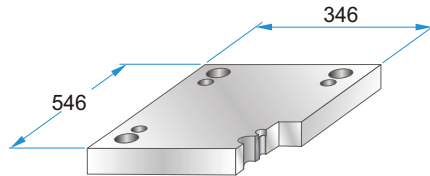
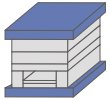

PK 11 - 296 x 546 x h /	material
PKA 11-296 x 546 x h /	
36	1730
46	2312
	2085

PK 02
PKA 02



PK 12
PKA 12



PK 21
PKA 21

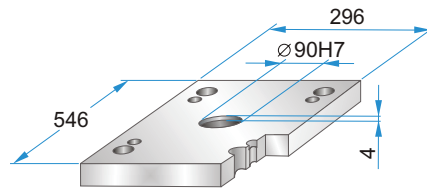

PK 21 - 296 x 546 x h /	material
PKA 21-296 x 546 x h /	
27	1730
36	2312
	2085

PK 22
PKA 22

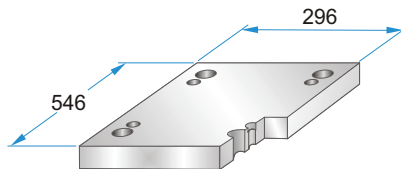

PK 22 - 296 x 546 x h /	material
PKA 22-296 x 546 x h /	
27	1730
36	2312
	2085

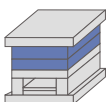

PK 03
PKA 03

PK 35
PKA 35

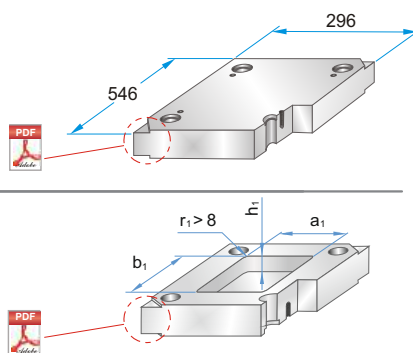

PK 03 - 296 x 546 x h /	material
PKA 03-296 x 546 x h /	
PK 35 - 296 x 546 x h /	material
PKA 35-296 x 546 x h /	(a ₁ /b ₁ /h ₁ /r ₁)
22	1730
27	2083
36	2085
46	2162
56	2311
66	2312
76	2738
86	Toolox33
96	Toolox44
116	2738HH
136	2714HH
156	

Corner undercuts upon request.
Podcięcia do demontażu na życzenie.
Abhebeecken erhältlich.
Доступно высвобождение на углах плит.

Material info



PK 31
PKA 31

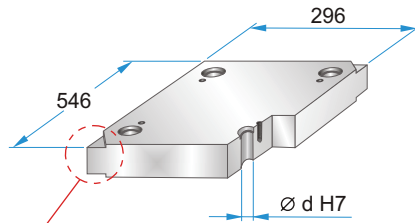
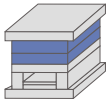

Corner undercuts upon request.
Podcięcia do demontażu na życzenie.
Abhebecken erhältlich.
Доступно высвобождение на углах плит.



	d
PK 31	29,4
PKA 31	29,5

PK 31 - 296 x 546 x h /
PKA 31-296 x 546 x h / material

27	1730
36	2083
46	2085
56	2162
66	2311
76	2312
86	2343
96	2738
116	2767
136	Toolox33
	Toolox44
	2738HH
	2714HH

Material info

PK 04
PKA 04

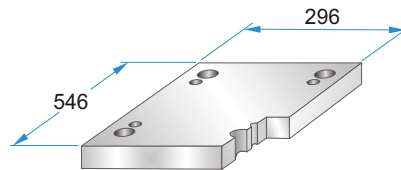
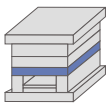

PK 04 - 296 x 546 x h /
PKA 04-296 x 546 x h / material

27	1730
36	2312
46	2085
56	
66	

PK 05
PKA 05



	A	B	M
PK 05	43	210	----
PKA 05	44	208	M10

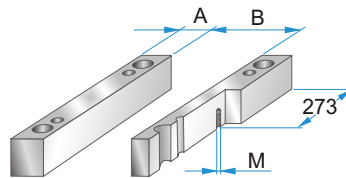

PK 05 - 296 x 546 x h /
PKA 05-296 x 546 x h / material

56	1730
66	2085
76	
86	
96	
116	
136	

PK 55
PKA 55



	A	B	M
PK 55	58	180	----
PKA 55	60	176	M10

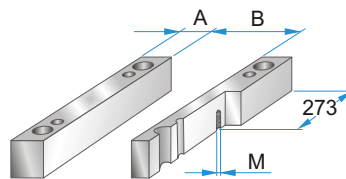

PK 55 - 296 x 546 x h /
PKA 55-296 x 546 x h / material

56	1730
66	2085
76	
86	
96	
116	
136	

PK 06
PKA 06

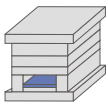

	A	B	C
PK 06	468	180	208
PKA 06	450	180	206

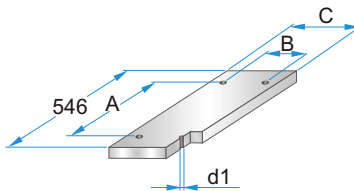

PK 06 - 296 x 546 x h /
PKA 06-296 x 546 x h / material

17	1730
22	2085

	d1
PK 06	M10
PKA 06	M8

PK 65
PKA 65



	A	B	C
PK 65	468	148	176
PKA 65	450	146	172

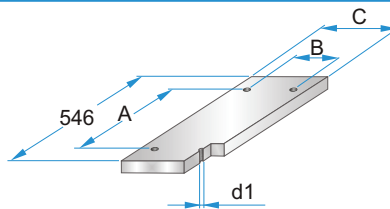

PK 65 - 296 x 546 x h /
PKA 65-296 x 546 x h / material

17	1730
22	2085

	d1
PK 65	M10
PKA 65	M8

PK 07
PKA 07

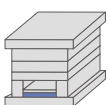

	A	B	C	D	M
PK 07	468	180	208	514	M4
PKA 07	450	180	206	520	M5

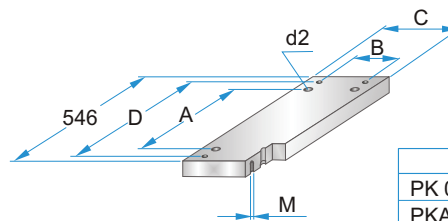

PK 07 - 296 x 546 x h /
PKA 07-296 x 546 x h / material

22	1730
27	2312
	2085

	d2
PK 07	M10
PKA 07	M8

PK 75
PKA 75

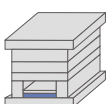

	A	B	C	D	M
PK 75	468	148	176	514	M4
PKA 75	450	146	172	520	M5

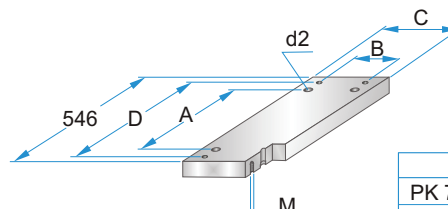

PK 75 - 296 x 546 x h /
PKA 75-296 x 546 x h / material

22	1730
27	2312
	2085

	d2
PK 75	M10
PKA 75	M8